

“SANMOTION Model No. PB” System Compliant with AC Power Input

Eiichi Nishio Masao Nagasato Ryuichi Yanagisawa
 Akihiro Matsumoto Masayoshi Kaneko Takehiro Matsumoto

1. Introduction

“SANMOTION Model No. PB” was produced to fulfill the gap between the open loop stepping system and AC servo system, and it was placed in the markets of the positioning equipment of the transport system, and fields of short stroke and high hit rate utilizing the characteristics of the stepping motor which is high torque when it is running slow.

In the recent years, with the speed up of the stepping system, increase in the reliability, and replacement from the servo system, a cost-sensitive, high-torque and high-performance solution is becoming the requirement, increasing the market request to the “SANMOTION Model No. PB”.

This section will explain the product outline and characteristics of the AC power supply input “SANMOTION Model No. PB” that was newly developed with these background.

2. Product Overview

2.1 Product architecture

Fig. 1 shows the exterior view of the amplifier and dimensional outline drawing, Fig. 2 shows the external wiring diagram, Table 1 shows the basic specification of the amplifier, and Table 2 shows the basic specification of the motor.

Power supply specification is set as AC 100 / 115 V in single phase and AC 200 / 230 V in single and 3 phases.

Lineup of the interfaces are in 4 models of combination of pulse-chain input and RS-485 / parallel I/O (Point, programmable: R Type).

Lineup of the motors are 5 models (see Table 2) in 42 mm square, 60 mm square, and 86 mm square, and single amplifier can be combined with all motors.

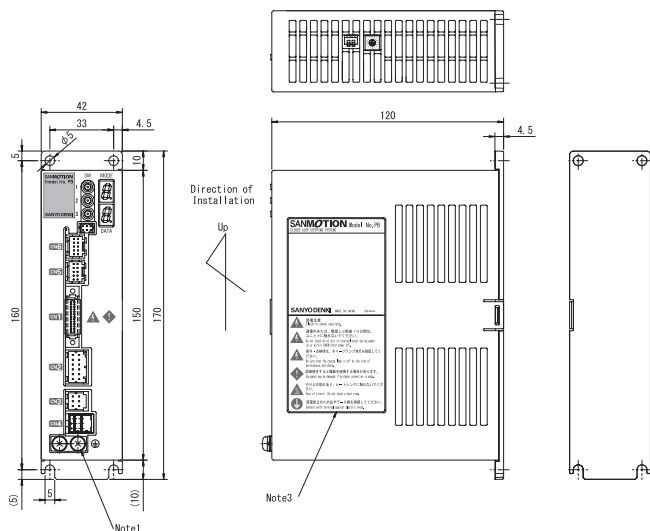

Fig. 1: Dimensional outline drawing / exterior view of the amplifier

Pulse-chain input

RS-485 / parallel I/O

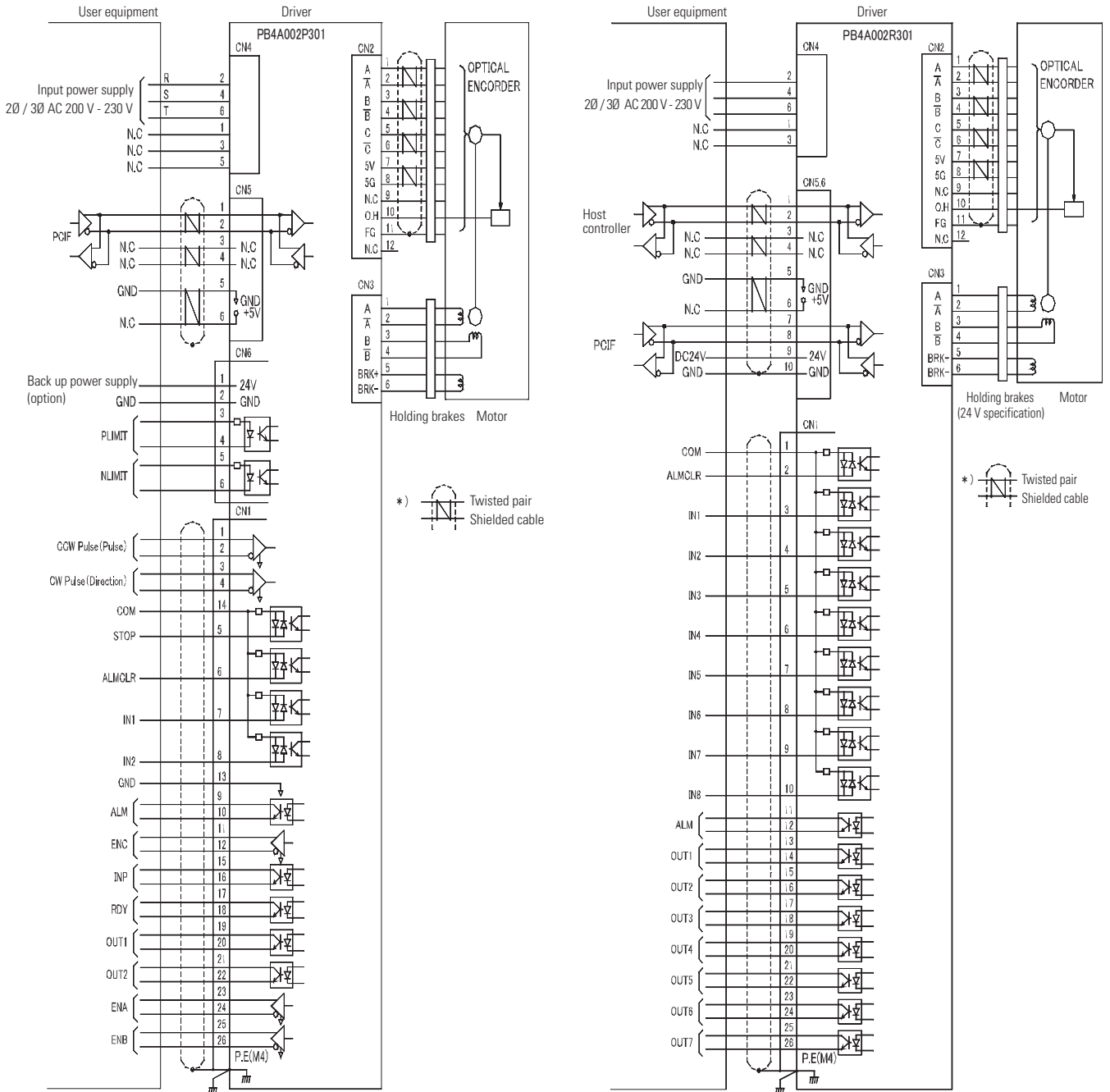

Fig. 2 External wiring diagram (for AC 200 V input)

Table 1: Basic specification of the amplifier

Item	Specification	
Amplifier model number	PB4A002 R 30*	PB4A002P30*
I/F	RS-485 half duplex/ parallel I/O	Pulse-chain input
Drive mode	Sine wave PWM control	
Input voltage	AC 100 / 115 V single phase, AC 200 - 230 V single and 3 phase + 10%, -15%	
External dimensions	H 150 × W 42 × D 120	
Weight	Approx. 0.64 kg	
Structure	Tray type	
Positioning resolution	Max. 3200 P / R (by electronic gear function)	
Rotation speed	0 - 4500 min ⁻¹ (42 mm - 60 mm square motor) 0 - 4000 min ⁻¹ (86mm square motor)	
Speed command resolution	1 min ⁻¹	—
Built-in functions	Holding brakes control function, regeneration control function	
	Point function, program function Teaching function	Auto-micro S-shape function
Operation function	Positioning function, jog operation, home return operation, forcing operation	
	Modulo function	—
Digital operator	Gain setting, motor combination, resolution, jog operation	
	Teaching function	Pulse-chain input method setting
Protection function	Motor overheating, amplifier overheating, power supply voltage error, sensor disconnection, over-speed, RST action, CPU error, EEPROM error, PAM voltage error, overloading error, overcurrent detection	
Input signal function	ALM CLR General purpose input: 8 (Point / PRG No, SELECT, EXE, HOME, Limit, Pause, STOP, Inter Lock, Jog, deviation clear, counter clear, brake control, etc.)	Pulse input: 1 or 2 input method H. Limit / SDN (common use), emergency stop, ALMCLR General purpose input: 2 (Deviation clear, force, current selection, brake control/, counter clear, etc.)
	ALM General purpose output: 7 (In-Position, Busy, Ack, ZONE, Point No, Push END, HOME END, etc.)	In-Position, Ready, encoder signal (A / B / C) General purpose output: 2 (HOME END, Push End, ZONE, input monitor, pulse inputting, etc.)

* Input/output signal function and logic is set by the communication

Table 2: Basic specification of the motor

	Item	PBM423FXK20	PBM603FXK20	PBM604FXK20	PBM861FXK20	PBM862FXK20
Basic specification	Max. stall torque (N · m)	0.39	1.3	1.9	3.5	6.6
	Rotor inertia (kg · cm²)	0.056	0.4	0.84	1.48	3
	Allowable thrust load (N)	9.8	14.7	14.7	60	60
	Allowable radial load (N)	49	167	167	200	200
	Motor mass (kg)	0.35	0.85	1.42	1.9	3.1
	Sensor specification	Optical INC 4000P/R A / B / C channels or phased origin signal				
Option	Holding brakes	○	○	○	×	×
	Low backlash gear	○	○	×	×	×
	Harmonic gear	○	○	×	×	×

3. Product features

3.1 Reduction of motor heat

Instead of supplying constant current as in open loop stepping system, “SANMOTION Model No. PB” only supplies necessary current depending on the operation status of the load by proportional and integral control, it has reduced the heating of the motor.

However, conventional AC power supply input “SANMOTION Model No. PB” had high response to current, but the current ripple relying on the current control system (PWM control) was so big, making the motor heating by the iron loss a problem for the multi-pole motor such as the stepping motor.

New control method to reduce the current ripple without impairing the responsiveness was innovated for the newly developed AC input “SANMOTION Model No. PB”, which made possible to reduce the heating of the motor vastly (80% reduction compared to conventional product: in case of 42 mm square motor). Fig. 3 shows the current waveform of the newly developed product and the conventional product.

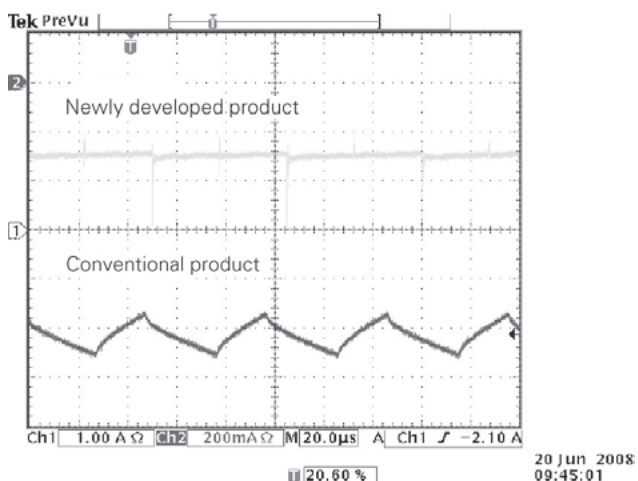

Fig. 3: Comparison of current waveform of the conventional product and the newly developed product (42 mm square: current when stopped)

3.2 Torque improvement

Applied voltage to the motor was restricted by the stepdown circuit due to the motor heat problem with the PWM system (stated in section 3.1) for the conventional product.

Therefore, there was a problem that there was not enough torque when running fast due to reduction of time constant of the current.

The newly developed product has realized the high torque and low power consumption by raising the motor applied voltage by eliminating the stepdown circuit with improvement of the PWM control system mentioned in the section 3.1, consideration of the optimal motor winding specification, and improvement of the motor efficiency.

Also, it has realized the reduction of number of parts by eliminating the stepdown circuit.

Fig. 4 shows the comparison data of the speed - torque characteristics and current consumption with 86 mm square size (PBM862) as an example.

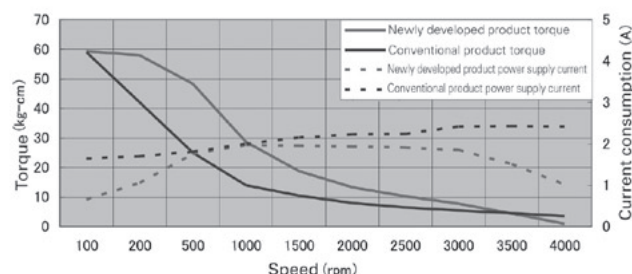

Fig. 4 Comparison of speed - torque characteristics / current consumption (motor model: PBM862)

3.3 Improvement of position accuracy

Conventionally, the control method of the motor when stopped was performed by using the self holding torque, which is a characteristic of the stepping motor, making the motor stopped completely by switching to open loop control when stopped against the closed loop control while moving.

However, when it is switched to open loop control, there was a drawback that the positioning accuracy was impaired when there is a load as shown in Fig. 5.

As an improvement method, a constantly closed loop control (servo lock) can be performed, but even though the positioning accuracy is maintained with this method, superiority of the complete stop is impaired due to occurrence of the minute vibration.

To resolve these problems, the resolution of the encoder was raised from 500 P/R to 4000 P/R (16000 P/R with 4 multiplier), which made possible to detect the minute angle of the position deviation during stopped, and by securing the superiority of the complete stop with a uniquely developed position compensation function, it has realized the improvement of the positioning accuracy (especially the repeatability) that is independent from the load condition.

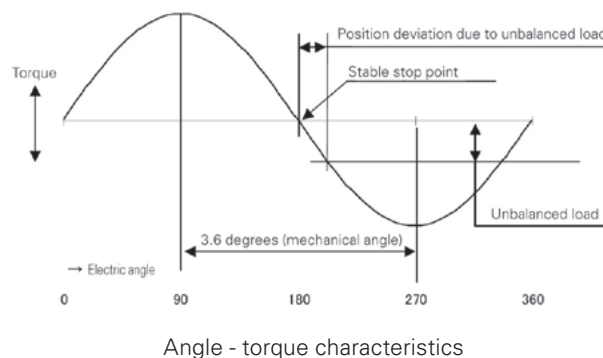

Fig. 5: Outline of position error by the unbalanced load

3.4 Improvement of the command synchronization

There are many merits with the proportional and integral control, such as avoidance of out of synchronism which is the drawback of the open loop control stepping motor and avoidance of velocity variation by resonance, then again, there are drawback that command synchronization (position deviation: difference of commanded position and actual position) is impaired.

Therefore, it was hard to implement to the application that this position deviation was a problem.

The newly developed pulse-chain input product, position deviation is reduced dramatically by installing the feed forward function to the positioning loop, and it was made available for the equipment that was hard to install by enhancing the deviation clearing operation methods on the equipment that needs to clear the position deviation by the external signal, such as labeling equipment.

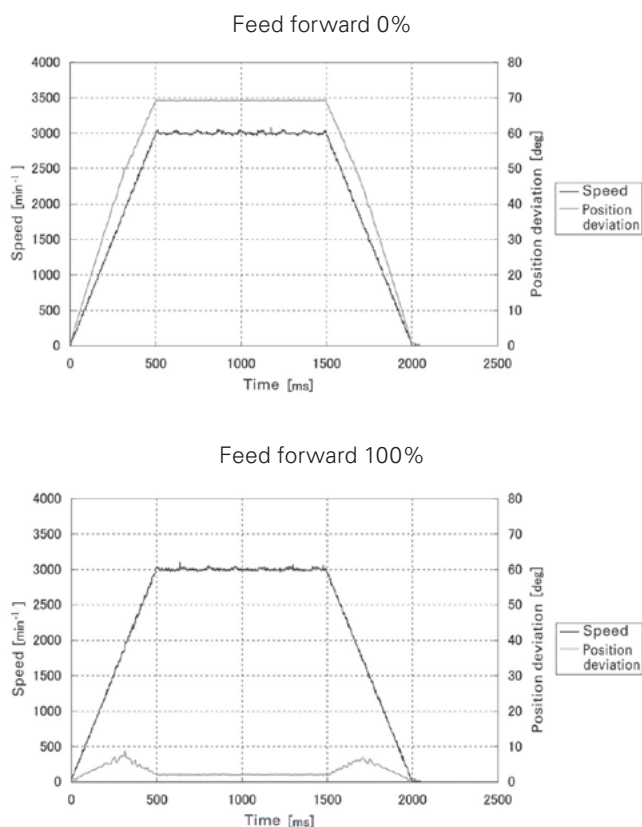

Fig. 6: Example of operation waveform by existence of the FF function

3.5 Others

Following user friendly function were installed as standard to enhance the usability:

- Improved the convenience of setting various parameters or test operation by newly installing the digital operator.
- Online / offline teaching function is now possible with digital operator only on the R Type.
- 7SEG LED is adopted as the display, making the confirmation of the alarm contents and amplifier status easy.
- Since the holding brake control function is built-in inside the amplifier as the conventional products, there is no need of holding brake power supply or relay contact.
- Since the unique regeneration control function is built-in inside the amplifier, there is no need of regeneration unit mounted externally.
- Forcing operation function is installed as standard for pulse input too, making it compatible to the electrification of the pneumatic equipment and others.

4. Conclusion

We think that the new products that can be implemented to various applications was developed by improving the performance and adding new functions.

We are planning to expand the “SANMOTION Model No. PB” series by challenging further enhancement of the performance by improvement of the characteristics of the motor itself, such as elimination of the magnetic sound that is the drawback of the stepping motor and improvement of the power rate, together with other improvement, considering to the environment aspects too.



Eiichi Nishio

Joined Sanyo Denki in 1985.
Servo Systems Division, 2nd Design Dept.
Worked on the development and design of servo amplifier.



Masao Nagasato

Joined Sanyo Denki in 1988.
Servo Systems Division, 2nd Design Dept.
Worked on the development and design of servo amplifier.



Ryuichi Yanagisawa

Joined Sanyo Denki in 1996.
Servo Systems Division, 2nd Design Dept.
Worked on the development and design of servo amplifier.



Akihiro Matsumoto

Joined Sanyo Denki in 1990.
Servo Systems Division, 2nd Design Dept.
Worked on the structural design of servo amplifier.

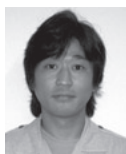

Masayoshi Kaneko

Joined Sanyo Denki in 1992.
Servo Systems Division, 3rd Design Dept.
Worked on the mechanism and electrical design of stepping motor.



Takehiro Matsumoto

Joined Sanyo Denki in 2005.
Servo Systems Division, 3rd Design Dept.
Worked on the mechanism and electrical design of stepping motor.

Memo